

AUSTRALIAN LIFTING CENTRE PTY LTD

NON-ALLOY & STAINLESS STEEL FITTINGS

AUSTLIFT



1300 100 120
WWW.AUSTLIFT.COM.AU

Contents



<i>Regular Proof Coil Galvanised Chain</i>	141
<i>Long Link Proof Coil Galvanised Chain</i>	141
<i>Security Chain</i>	141
<i>S Hook</i>	142
<i>Quick Link</i>	142
<i>Snap Hook</i>	142
<i>Split Repair Link</i>	143
<i>Lynch Pin</i>	143
<i>R Clips</i>	143
<i>Turnbuckle AISI 316 Hook & Eye</i>	144
<i>Turnbuckle AISI 316 Clevis & Clevis</i>	144
<i>Bottle Screws AISI 316 Toggle & Swage Stud</i>	144
<i>Stainless Steel</i>	144
<i>Bottle Screw AISI 316 Clevis Toggle & Toggle</i>	145
<i>Eyebolt AISI316 Long Shank C/W Nut & Washer</i>	145
<i>Wire Rope Grips AISI316</i>	145
<i>Wire Rope Thimbles AISI316</i>	145
<i>Eyenuits AISI 316</i>	146
<i>Eyebolt With Collar AISI 316</i>	146
<i>Standard Dee Shackles AISI 316</i>	146
<i>Snap Hook AISI 316 C/W Eyelet</i>	146
<i>S-Hook AISI 316</i>	147
<i>Fork Terminal AISI 316</i>	147
<i>Round Ring AISI 316</i>	147
<i>Saddles AISI 316</i>	147

AUS

Regular Link, Proof Loaded, Galvanised Chain

Austlift Proof loaded Chain are manufactured from low carbon steel and come in a variety of link formations and used for agricultural, industrial, manufacturing, marine and general engineering applications.

- General purpose Chain with a variety of link dimensions
- Manufactured from low grade carbon steel
- Available in regular link and long link.
- Packed in 50kg pails and 500kg drum and cut length.
- Available in self colour, hot dip galvanized and zinc finish.
- NOT SUITABLE FOR LIFTING APPLICATIONS

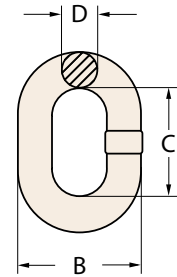

50KG PAIL PAK 			DIMENSIONS			500KG DRUM 		CUT LENGTH
CODE	SIZE	LENGTH	B	C	D	CODE	LENGTH	CODE
Nº	mm	Mtr	mm	mm	mm	Nº	Mtr	Nº
705003	3	249	13.1	15.7	3	-	-	-
705004	4	153	16	18.6	3.8	-	-	-
705005	5	96.5	19.4	22	4.75	705105	965	703705
705006	6	60	23.5	26	6	705106	600	703706
705008	8	37	29.5	32	7.6	705108	370.5	703708
705010	10	23.5	36	39	9.5	705110	235.5	703710
705013	13	13.8	46	49	12	705113	138.5	703713
705016	16	9	56	60	16	705116	91	703716

*J705010: 10mm x 12Metres in 25kg Pail.



- NOT FOR LIFTING APPLICATIONS

Long Link, Proof loaded, Galvanised Chain

50KG PAIL PAK 			DIMENSIONS			500KG DRUM 		CUT LENGTH
CODE	SIZE	LENGTH	B	C	D	CODE	LENGTH	CODE
Nº	mm	Mtr	mm	mm	mm	Nº	Mtr	Nº
704105	5	103	21.8	29.3	5	704205	1030	704305
704106	6	64	26.1	34.5	6.3	704206	640	704306
704108	8	39	31.9	41.3	8	704208	390.5	704308
704110	10	25	38.7	49	10	704210	251	704310

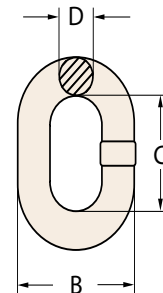
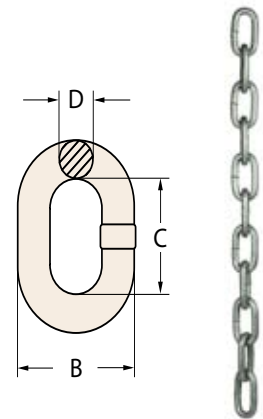

NOTE: Dimensions stated are approximate and subject to commercial tolerances.

Regular Link G316 Stainless Steel Chain

Austlift Stainless Steel Chain is manufactured from G316 Stainless which is highly resistant to corrosion in acid and alkaline and is well suited for Marine applications

- Available in a drum or cut lengths to suit your requirements
- NOT FOR LIFTING APPLICATIONS

500KG DRUM			DIMENSIONS			CUT LENGTH
CODE	SIZE	LENGTH	B	C	D	CODE
Nº	mm	Mtr	mm	mm	mm	Nº
706004	4	1644	7	19	4	706104
706006	6	717	27	27	6	706106
706008	8	386	32	32	8	706108
706010	10	250	38	38	10	706110

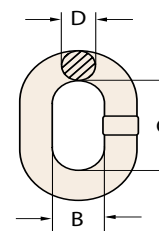
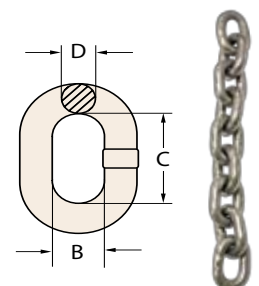

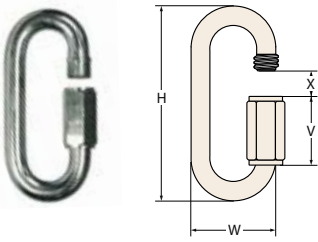

Austlift Quick Links are used as a temporary way to connect commercial fittings commonly used with Chain.

- Manufactured with low carbon steel.
- Sizes available from 4mm to 16mm.
- Oval shaped with a hex screw lock gateway.
- Available in zinc plated finish only.
- NOT FOR LIFTING APPLICATIONS.

CODE	SIZE	OPENING	DIMENSIONS		
	mm	SIZE mm	H mm	V mm	W mm
701504	4	5.5mm	39	12.5	19
701505	5	6.5mm	48	15	23
701506	6	7.5mm	57	19	26
701508	8	10mm	76	23	34
701510	10	12mm	89	29	40
701512	12	15mm	107	32	49
701516	16	19mm	140	43	61

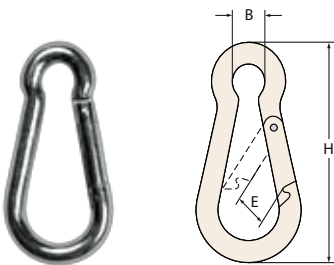

Austlift Snap Hooks are used as a temporary way for connecting commercial products and as a light duty hanging devise that snap lock.

- Manufactured with low carbon steel.
- Sizes available from 4mm to 15mm
- Key hole shaped with a spring catch.
- Available in zinc plated finish only.
- NOT FOR LIFTING APPLICATIONS.

CODE	SIZE	DIMENSIONS		
	mm	B mm	E mm	H mm
702004	4	7	7	40
702005	5	8	7	50
702006	6	9	8	60
702008	8	12	9	80
702010	10	15	11	100
702012	12	20	19	140
702015	15	22	35	200

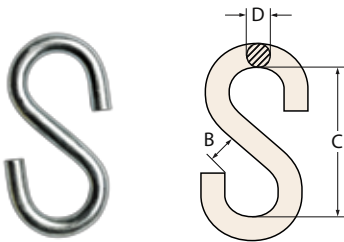

Austlift S-hooks are commonly used as a hanging devise and other general purpose applications

- Manufactured with low carbon steel.
- Sizes available from 3mm to 10mm
- S shaped hook.
- Available in zinc plated finish only.
- NOT FOR LIFTING APPLICATIONS.

CODE	SIZE	DIMENSIONS		
	mm	B mm	C mm	D mm
703003	3	4	23.8	3
703004	4	5.5	31.8	4
703005	5	8	39.7	5
703006	6	8.7	47.6	6
703008	8	11.9	65.1	8
703010	10	13.5	80.1	9.5

Austlift Split Links are used as a more permanent way to connect commercial fittings commonly used with Chain products.

- Manufactured from mild steel
- Sizes available from 3mm to 13mm.
- Chain link shaped with large split gap for ease of attachment.
- Electroplated finish for anti-corrosion and ease of welding.
- NOT FOR LIFTING APPLICATIONS.

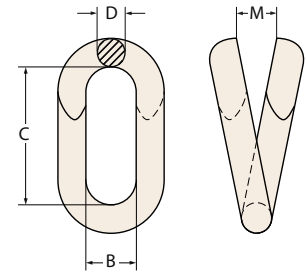

CODE	SIZE	DIMENSIONS			
	mm	B mm	C mm	D mm	M mm
701030	3	6.5	16.5	3	4
701040	4	8	20	4	5.5
701050	5	9.5	23	5	6
701060	6	10.5	29	6	7
701080	8	15	37	8	9
701110	10	17	37.5	10	10
701130	13	20	40	13	13

Lynch Pin

Austlift Lynch Pins are commonly used as a positive securing device for shaft pins.

- Pin sizes from 4mm to 10mm available
- Made from low carbon steel and zinc plated.
- NOT FOR LIFTING APPLICATIONS.

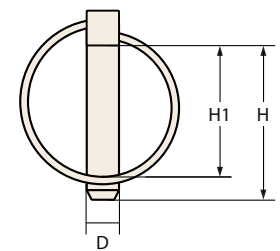

CODE	DIMENSIONS		
	D mm	H mm	H1 mm
701304	4	40	32.5
701306	6	40	32.5
701308	8	40	32.5
701310	10	40	34.5

R Clips

Austlift R-Clips are commonly used as a removable securing pin for shafts.

- Pin sizes from 3mm to 6mm available.
- Made from low carbon steel and zinc plated.
- NOT FOR LIFTING APPLICATIONS.

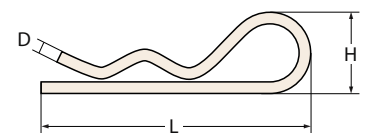
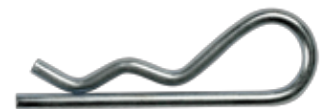

CODE		DIMENSIONS		
		D(mm)	L(mm)	H(mm)
701203	3mm Wire Suite 10-12mm Shaft	3	67	20
701204	4mm Wire Suite 12-22mm Shaft	4	88	28
701205	5mm Wire Suite 16-27mm Shaft	5	106	35
701206	6mm Wire Suite 19-32mm Shaft	6	120	44



STAINLESS STEEL FITTINGS NOT FOR LIFTING APPLICATIONS.

Turnbuckle AISI 316 Hook & Eye

Austlift Stainless Steel Hook and Eye Turnbuckles used as a tensioning device and commonly use for Architectural, Rigging and Marine applications.

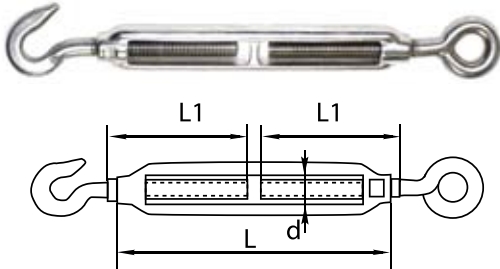

Code:	720305	720306	720308	720310	720312	720316
Size(d) MM	M5	M6	M8	M10	M12	M16
L	70	90	120	150	200	250
L1	35	44	59	73	95	116

Turnbuckle AISI 316 Clevis & Clevis

Austlift Stainless Steel Clevis and Clevis Turnbuckles used as a tensioning device and commonly use for Architectural, Rigging and Marine applications.

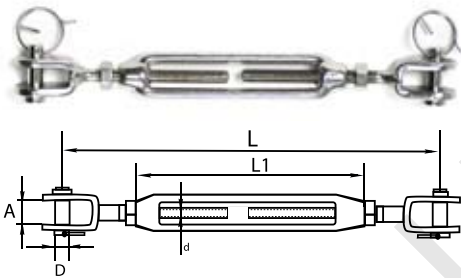

Code:	720505	720506	720508	720510	720512	720516
Size(d) MM	M5	M6	M8	M10	M12	M16
L	121	145	180	225	300	380
L1	70	90	120	150	200	250
A	6	7.5	10	12	14	16
D	5.2	6.2	8.7	9.7	12.6	16

Bottle Screws AISI 316 Toggle & Swage Stud

Austlift Stainless Steel Clevis Toggle and Stud Bottle Screw used as a tensioning device and commonly use for Architectural, Balustrade Rigging and Marine applications.

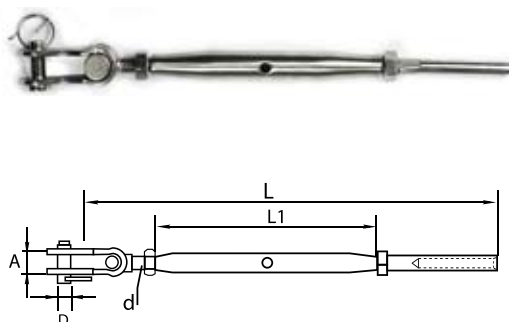

Code:	721008	721010	721012	721016	721020
Size(d) MM	M8	M10	M12	M16	M20
L	208	250	297	396	458
L1	105	125	150	190	210
A	9	12	13	18	22
D	8	9	12	16	19
ROPE(Φ)	4	5	6	8	10

Bottle Screw AISI 316 Clevis Toggle & Toggle

Austlift Stainless Steel Clevis Toggle and Toggle Bottle Screw used as a tensioning device and commonly use for Architectural, Balustrade Rigging and Marine Applications.

Code:	720908	720910	720912	720916	720920
Size(d) MM	M8	M10	M12	M16	M20
L	195	223	275	405	472
L1	105	125	150	190	210
A	9	12	13	18	22
D	8	9	12	16	19

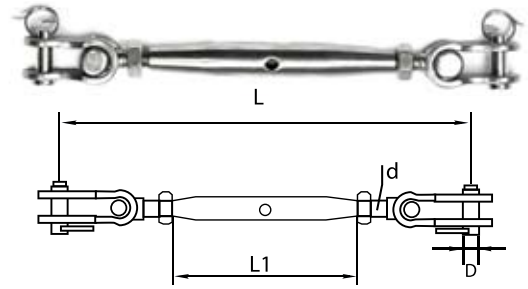

Wire Rope Grips AISI 316

Austlift Stainless Steel Wire Rope Grips are for use with Stainless Wire Rope to form a loop to produce a termination for Architectural Rigging applications.

Code:	721203	721204	721205	721206	721208	721210	721212
Size MM	3	4	5	6	8	10	12
B	17	20.5	20.5	27.5	33	41	49
C	7.6	9.5	11.5	13.5	17	21	24.5
A	M3	M4	M5	M6	M8	M10	M12

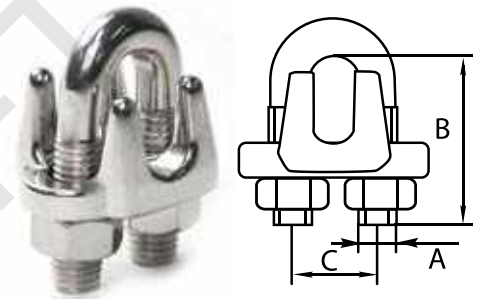

Wire Rope Thimbles AISI 316

Austlift Stainless Steel Wire Rope Thimbles are for use with Stainless Wire Rope to form a protective loop to produce a termination for Architectural Rigging applications.

Code	721403	721404	721405	721406	721407	721408	721410	721412	721413
Size MM	2.5x3	3.5x4	4x5	5x6	6x7	7x8	9x10	10x12	12x13
D	12	13	14	16	18	20	24	28	30
H	19	21	23	25	28	32	38	45	48
B	3	4	5	6	7	8	10	12	13

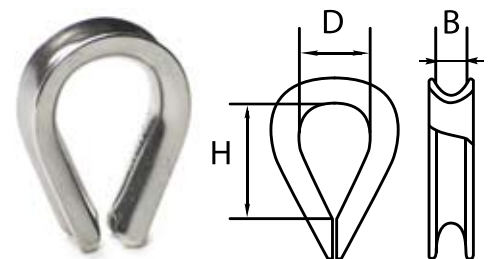

Eyebolt AISI 316 Long Shank C/W Nut & Washer

Austlift Stainless Steel Collared Eye Bolt Long Shank, used as an anchor point and with long shank has a wide variety of applications.

Code:	722006	722008	722010	722012
Size(D) MM	M6x80	M8x80	M10x100	M12x120
D	26	31	39	45
Φ	16	19	25	29
H	30	34	42	47

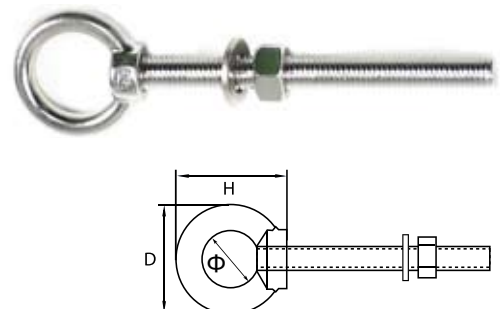

Eyebolt with Collar AISI 316

Austlift Stainless Steel Collared Eye Bolt, used as an anchor point and has a wide variety of applications.

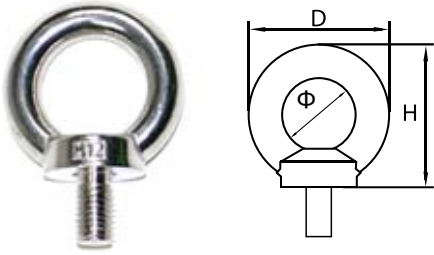

Code:	721606	721608	721610	721612	721616
Size(D) MM	M6	M8	M10	M12	M16
D	36	36	45	54	63
Φ	20	20	25	30	35
H	36	36	45	53	62

Austlift Stainless Steel Collared Eye Nut, used as an anchor point and has a wide variety of applications.

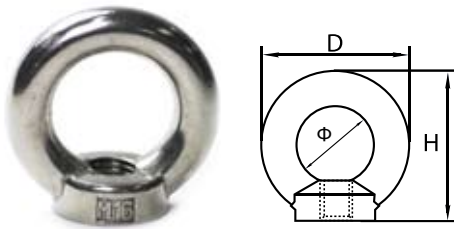

Code:	721806	721808	721810	721812	721816
Size(D) MM	M6	M8	M10	M12	M16
D	36	36	45	54	63
Φ	20	20	25	30	35
H	36	36	45	53	62

Standard Dee Shackles AISI 316

Austlift Stainless Steel Dee Shackles, used as a temporary connection devise and has a wide variety of applications.

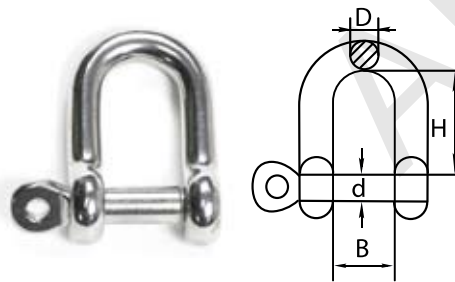

Code:	720106	720108	720110	720112	720116
Size(D) MM	6	8	10	12	16
d	6	8	10	12	16
B	13	17	18	25	32
H	22	29	32	40	52

Snap Hook AISI 316 C/W Eyelet

Austlift Stainless Steel Snap Hook, used as a temporary connection devise and has a wide variety of applications.

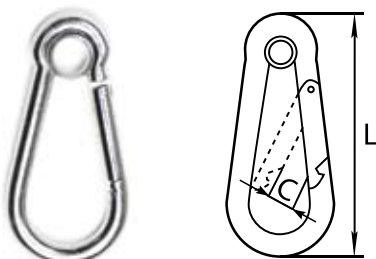

Code:	722206	722207	722208	722209	722210	722211	722212
Size MM	6	7	8	9	10	11	12
L	60	70	80	90	100	120	140
C	8	8	9	10	11	16	19

Austlift Stainless Steel Fork Terminal used as a wire termination and commonly use for Architectural, Balustrade, Rigging and Marine applications.

Code:	722604	722605	722606	722607	722608	722609	722610
Size MM	4	5	6	7	8	9.5	10
A	10	12	14	14.5	16	17	17
D	6.2	8.7	9.7	12.6	14.6	16.5	16.5
L1	40	57	63	70	85	87	89
L	77	88	106	116	145	150	150

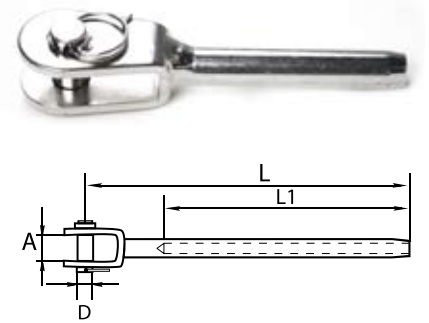

S-Hook AISI 316

Austlift Stainless Steel S-Hook used as a hooking devise and has a wide variety of applications

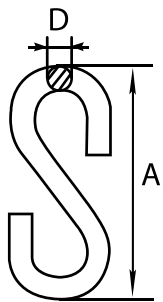

Code:	722405	722406	722407	722408
Size INCH	3/16	1/4	9/32	5/16
D	5	6	7	8
A	50	60	76	80

Round Ring AISI 316

Austlift Stainless Steel Round Ring used as a ring devise and has a wide variety of applications

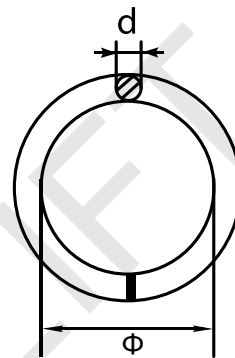

Code:	722805	722806	722807	722808	722809	722810
Size(d) MM	5	6	7	8	9	10
Φ	50	60	60	80	80	80

Slide Buckle AISI 316

Austlift Stainless Steel Slide Buckle used as an adjustable fitting for webbing and has a wide variety of applications



Code:	723006
Size MM	3
A(mm)	65
a(mm)	51
B(mm)	34
E(mm)	6

Saddles AISI 316

Austlift Stainless Steel Saddle used as an anchor point and has a wide variety of applications

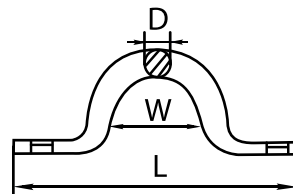

Code:	723206	723208	723210
Size (D) mm	6	8	10
L	60	63	75
W	15	17	20

Austlift Stainless Steel Wire Rope Products
Please check Page 153

AUSTLIFT

SYDNEY

43 Frank Street Wetherill Park, NSW 2164
T. 02 9757 2277 F. 02 9757 2922

MELBOURNE

47 Technology Drive, Sunshine West VIC 3020
T. 03 9314 5525 F. 03 9314 5526

PERTH

Unit 5, 2-4 Mallaig Way Canning Vale WA 6155
T. 08 9256 3440 F. 08 9256 4408

BRISBANE

7 Durbell St Acacia Ridge, QLD 4110
T. 07 3272 0777 F. 07 3272 0788

www.austlift.com.au