

AUSTRALIAN LIFTING CENTRE PTY LTD

LOAD RESTRAINT & 4WD RECOVERY

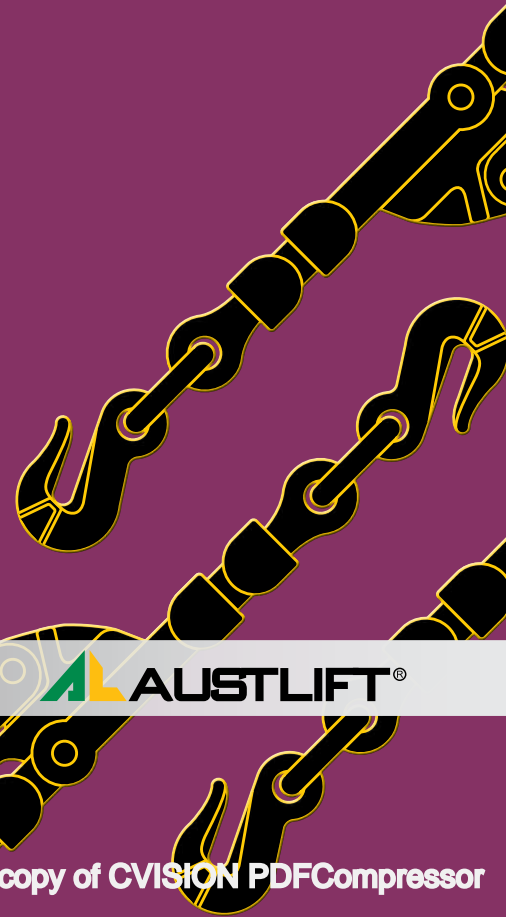

 **AUSTLIFT®**

1300 100 120
WWW.AUSTLIFT.COM.AU

Contents

<i>Maxibinder</i>	69
<i>Auswinch Features</i>	69
<i>Standard Lever Style</i>	70
<i>Ratchet Lever Style</i>	71
<i>Web Dog</i>	71
<i>Grab Hook</i>	72
<i>Claw Hook</i>	72
<i>Clevis Lug Links</i>	72
<i>Recovery Drag Chain Kit</i>	73
<i>Transport Chain Kit</i>	73
<i>Clevis Slip Hook</i>	73
<i>Cargo Bar</i>	74
<i>Shoring Bar</i>	74
<i>Transport Chain</i>	74
<i>Jack Bar</i>	75
<i>Winch Track</i>	75
<i>Winch Bars</i>	75
<i>Ratchet Tie Downs</i>	76
<i>Motorbike Tie Downs</i>	76
<i>25mm Webbing</i>	76
<i>'Ergo' Ratchet Tie Downs</i>	77
<i>Truck (Replacement) Winch Straps</i>	77
<i>Silver Rope</i>	78
<i>Silver Rope Hanks</i>	78
<i>Using Ropes and Knots</i>	78
<i>Rubber Tarp Straps</i>	79
<i>Snatch Straps</i>	79
<i>Vehicle Ratchet Tie Down</i>	79
<i>Do Not Overtake Sign</i>	79
<i>Truck Winches</i>	80
<i>Ratchet Buckles</i>	82
<i>End Fittings</i>	83
<i>Maxibinder Spare Parts</i>	84
<i>Lashing User Guide</i>	85
<i>Grab Hook</i>	88
<i>4WD RECOVERY</i>	88





- International patent No.: PCT/AU2006/000827
- Australian patent No.2006301899
- US patent application No.:11/992108(Patent pending)
- Canada patent application No.:2622269 (Patent pending)
- Ergonomically designed
- Safer, quicker & easier to use
- High pre-tensioning force
- 1/8 Chain link length adjustment
- Alloy steel, heat treated for durability
- Conforms to AS/NZ4344 standard.
- Multiple purposes
- Designed for a higher pre-tensioning strength
- Designed and manufactured by Australian Lifting Centre.

CODE	CHAIN SIZE	LC	WEIGHT	CHAIN LENGTH
		kg	kg	metres
202705	8mm	3800	4.8kg	0.5

Auswinch Features

AUSWINCH

Ratchet winch with 21 teeth double pawl locking device .

International Patent No PCT/AU2009/001455

Australian Patent No 2008905987

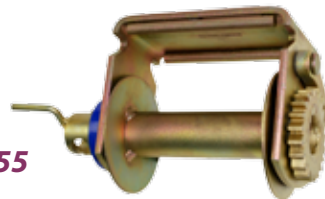

Our research and development team have come up with a new innovation in Truck Winch which gives the benefits of high pretension with 30% less effort for the operator over other Winches in the market place. This registered design in the gear and pawl has become the most advanced Winch in Australia .All Loadmax Winches have this feature as standard.

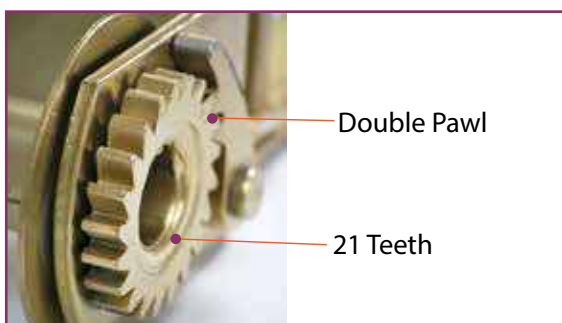

Our manufacturer has come up with a patent design in Truck Winches with the feature of a ratcheting head design which gives the benefits of quick take up of strap also provides limited ratcheting angles when in operation.All Loadmax ratchet head Winches are available.

Standard Lever Style

Grab Hooks with supporting lugs

Loadmax Lever style Load Binder with winged Grab Hooks combined with Grade 70 Chain are an effective way to restraint heavy loads for transport operations. Commonly used to tie down Steel, Plant Equipment, Timber and other general cargo applications.

- Load Binder to suit Chain sizes from 6mm to 13mm available.
- Manufactured from dropped forged steel quenched and tempered.
- Marked with Chain size, lashing capacity, grade, batch numbered and branded Loadmax for traceability
- All Load Binders come with swivel winged Grab Hooks to achieve full lashing capacity
- Batch Test Certificate available upon request.
- Comply with AS 4344.

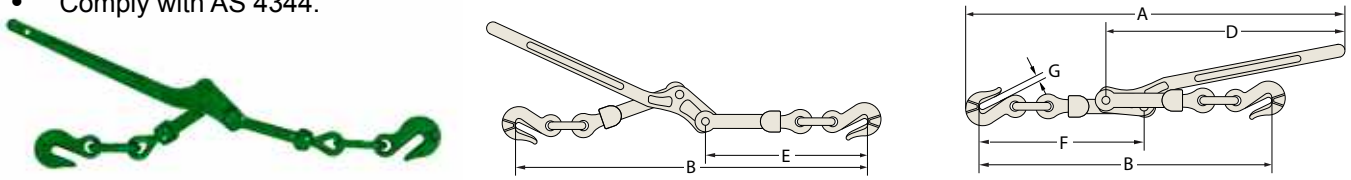

CODE	CHAIN SIZE	LASHING CAPACITY		MBF	Wt.	DIMENSIONS						
		G70 Chain	G80 Chain			KN	kg	A mm	B mm	C mm	D mm	E mm
202006	6	2300kg	2300kg	44	2.4	540	475	390	390	225	220	8.9
202008	7 - 8	3800kg	4100kg	84	3.2	610	560	455	405	265	264	12.7
202010	10	6000kg	6400kg	125	5.6	730	655	540	420	313	315	16
202013	13	9000kg	10500kg	205	8.9	790	830	635	535	370	350	18

Safety Lever Style (BX600)

Grab Hooks with supporting lugs

Loadmax Safety Lever style Load Binder with winged Grab Hooks combined with Grade 70 Chain are an effective way to restraint heavy loads for transport operations with the added safety feature of a recoilless handle.

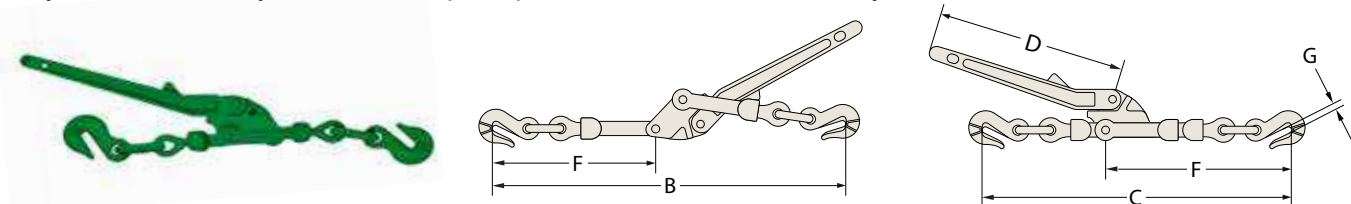

CODE	CHAIN SIZE	LASHING CAPACITY		MBF	Wt.	DIMENSIONS				
		G70 Chain	G80 Chain			KN	kg	C mm	D mm	E mm
202615	8	3,800kg	4,100kg	85	4.2	600	320	280	280	940
202620	10	6,000kg	6,400kg	130	6.5	720	380	320	320	1020

Standard Lever Style

Claw Hooks

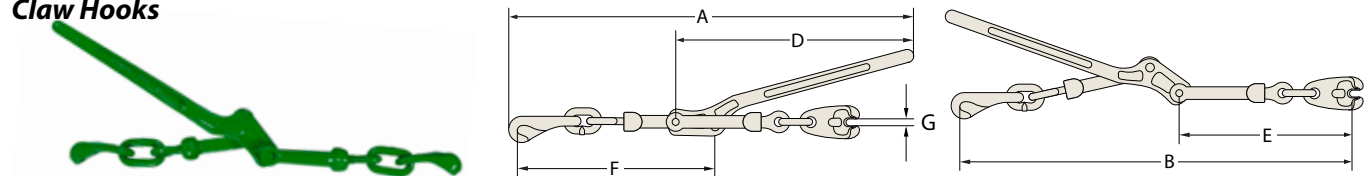

CODE	CHAIN SIZE	LASHING CAPACITY		MBF	Wt.	DIMENSIONS						
		G70 Chain	G80 Chain			KN	kg	A mm	B mm	C mm	D mm	E mm
202108	8	3800kg	4100kg	84	3.9	635	640	545	395	310	310	11.9
202110	10	6000kg	6400kg	125	5.6	715	729	625	445	345	345	14.9

Loadmax Ratchet style Load Binder with winged Grab Hooks combined with Grade 70 Chain are an effective way to restraint heavy loads for transport operations, With the benefit of high pretension and the added safety of screw stops to ensure full thread contact while in use.

- Load Binder to suit Chain sizes from 6mm to 13mm available.
- Manufactured from dropped forged steel quenched and tempered.
- Marked with Chain size, lashing capacity, grade, batch numbered and branded Loadmax for traceability
- All Load Binders come with swivel winged Grab Hooks to achieve full lashing capacity.
- Comply with AS 4344, Batch Test Certificate available upon request.

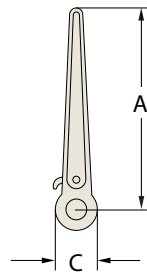
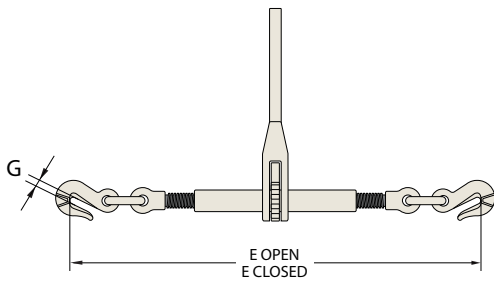

CODE	CHAIN SIZE	LASHING CAPACITY		MBF	Wt.	DIMENSIONS				
		G70 Chain	G80 Chain			KN	kg	A mm	C mm	E-Open mm
202206	6	2300kg	2300kg	46	1.69	210	42	528	415	10
202208	8	3800kg	4100kg	74	4.9	355	65	754	590	11
202210	10	6000kg	6400kg	118	5.4	355	65	775	610	12
202213	13	9000kg	10500kg	176	7.5	355	65	870	700	15

NEW



Loadmax Web Dog is a safe alternative to Load Binders
Web Dogs overcome the dangerous kick-back associated with load binders. Comply with AS 4344.

CODE	LC	END FITTING	Wt.	WEBBING SIZE
202703	3800KG	G70 SWIVEL GRAB HOOK	4KG	50mmx0.94M

Grab Hook
with supporting lugs



Note: G70 Chain & fittings not to be used for lifting purposes.

Loadmax Clevis Winged Grab Hooks combined with Grade 70 Chain are an effective way to restraint heavy loads for transport operations with the benefit of a cradle built into the hook to achieve full lashing capacity.

- Sizes available from 6mm to 13mm.
- Manufactured from dropped forged steel quenched and tempered and gold zinc plated.
- Marked with Chain size, lashing capacity, grade, batch numbered and branded Loadmax for traceability
- Comply with AS 4344, Batch Test Certificate available upon request.

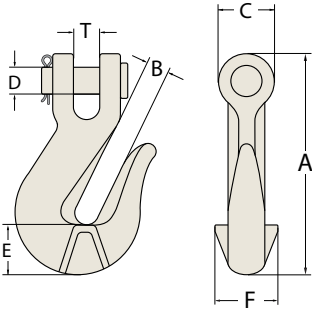

CODE	SIZE	L.C	Wt.	DIMENSIONS						
				A	B	C	D	E	F	T
	mm	kg	kg	mm	mm	mm	mm	mm	mm	mm
201006	6	2300	0.23	77	8.5	21	8.5	18.5	24.5	10
201008	8	3800	0.35	95	12	23	11.5	24.5	31.5	11.5
201010	10	6000	0.57	112	13	28	12.5	29	40	13
201013	13	9000	0.92	136	16	32	16.8	44	43	16

Claw Hook



Loadmax Clevis Claw Hooks combined with Grade 70 Chain are an effective way to restraint heavy loads for transport operations with the benefit of full lashing capacity together with in line tension.

- Sizes available from 8 and 10mm.
- Manufactured from dropped forged steel quenched and tempered and gold zinc plated.
- Marked with Chain size, lashing capacity, grade, batch numbered and branded Loadmax for traceability
- Comply with AS 4344, Batch Test Certificate available upon request.

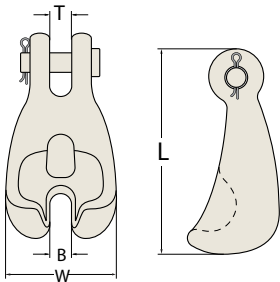

CODE	SIZE	L.C	Wt.	DIMENSIONS			
				B	T	W	L
	mm	kg	kg	mm	mm	mm	mm
201108	8	3800	0.15	9.5	12.5	47	88.22
201110	10	6000	0.30	11.5	12.5	55	103.3

Clevis Lug Links



Loadmax Clevis Lug Links combined with Grade 70 Chain are an effective way to restraint heavy loads for transport operations with the benefit of a loop to use as a tow or anchor point, Commonly used for drag Chain applications.

- Sizes available from 8 to 13mm.
- Manufactured from dropped forged steel quenched and tempered and gold zinc plated.
- Marked with Chain size, lashing capacity, grade, batch numbered and branded Loadmax for traceability.
- Comply with AS 4344, Batch Test Certificate available upon request.

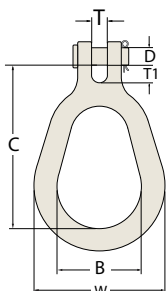

CODE	SIZE	L.C	Wt.	DIMENSIONS					
				B	C	D	T	T1	W
	mm	kg	kg	mm	mm	mm	mm	mm	mm
201208	8	3800	0.15	53	108	9	11	15	86
201210	10	6000	0.30	55	110	11	12	15	86
201213	13	9000	0.55	65	128	15	18	15	100

Clevis Slip Hook

Loadmax Clevis Slip Hooks combined with Grade 70 Chain are an effective way to restraint heavy loads for transport operations with the benefit of a hook style fitting for all sorts of lashing applications.

- Sizes available from 6 to 13mm.
- Manufactured from dropped forged steel quenched and tempered and gold zinc plated.
- Marked with Chain size, lashing capacity, grade, batch numbered and branded Loadmax for traceability
- Comply with AS 4344, Batch Test Certificate available upon request.

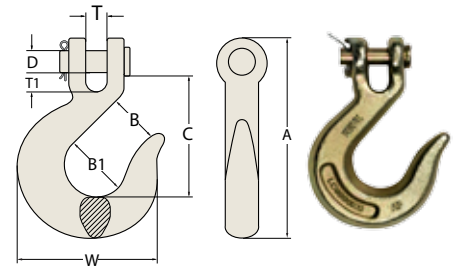

CODE	SIZE	L.C	Type	Wt.	DIMENSIONS							
					mm	kg	kg	A (mm)	B (mm)	B1 (mm)	C (mm)	D (mm)
201306	6	2000	Clevis	0.22	102	24	30	66	7.8	11	11.4	70
201308	8	3800	Clevis	0.33	114	27	32	74	9.9	13	13.4	75
201408	8	3800	Eye	0.33	114	27	32	74	9.9	13	13.4	75
201310	10	6000	Clevis	0.5	132	33	38	85	12	15	15.5	88
201313	13	9000	Clevis	1.23	166	43	49	103	16	19	19.6	123

Recovery Drag Chain Kit

Loadmax G70 Drag Chain kits give considerably higher load bearing capacity when required for 4WD recovery, towing, logging and other agricultural applications .

- Size available from 8 to 13mm and supplied with Lug link, Grab hook or Slip hook.
- Supplied at 5 metre length as standard however longer lengths can be supplied upon request.
- All Grade 70 Drag Chain Kits come with re-usable plastic containers.
- Comply with AS 4344, Batch Test Certificate available upon request.

CODE	SIZE
Lug Link Grab Hook	Chain size x L
203408	8mm X 5M
203410	10mm X 5M
203413	13mm X 5M



Transport Chain Kit

CODE	CHAIN SIZE	HOOK TYPE	L.C
	Dia x Lth	Description	kg
203200	6mm X 6M	Grab Hook	2300
203205	6mm X 9M	Grab Hook	2300
203205NH	6mmx9M	No Grab Hook	2300
203210	8mm X 6M	Grab Hook	3800
203211	8mm X 7M	Grab Hook	3800
203215	8mm X 9M	Grab Hook	3800
203220	10mm X 5M	Grab Hook	6000
203320	10mm X 6M	Grab Hook	6000
203225	10mm X 9M	Grab Hook	6000
203230	13mm X 9M	Grab Hook	9000
203314	8mm X 6M	Claw Hook	3800
203315	8mm X 9M	Claw Hook	3800
203325	10mm X 9M	Claw Hook	6000



Loadmax G70 Transport Chain Kits give the benefits of cleanliness, lightweight, strength and reliability therefore making it ideal for tie-down applications for the transport and shipping industries.

- Size available from 6 to 13mm and supplied with Grab Hook or Claw Hook.
- Any lengths can be supplied with other fittings upon request.
- All Grade 70 Transport Chain Kits come with re-usable plastic containers.
- Comply with AS 4344, Batch Test Certificate available upon request.

Transport Chain

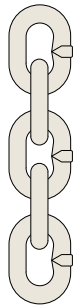



Loadmax G70 Transport Chain gives the benefits of cleanliness, lightweight, strength and reliability therefore making it ideal for tie-down applications for the transport and shipping industries.

- G70 Chain available from 6 to 13mm and gold zinc finish.
- Marked with 4344(lashing capacity in tonnes) with AL for traceability.
- Available in 50kg pails or 500kg drum lots also any lengths can be supplied upon request.
- Comply with AS 4344, Batch Test Certificate available upon request.



Grade 70 Chains **MUST NOT** be used for lifting purposes.

500KG/DRUM	50KG PAIL	CUT LENGTH	SIZE	L.C	50KG LENGTH
					
CODE	CODE	CODE	mm	KG	M
203006	203106	203306	6	2300	62.5
203007	203107	203307	7.1	3000	46
203008	203108	203308	8	3800	35
203010	203110	203310	10	6000	22.5
203013	203113	203313	13	9000	13.4

Note: The above 50KG/M length is a guide only & may vary in length by different manufactures.

Cargo Bar



Loadmax Cargo Bar fitted with adjustable ratchet and rubber padded feet is the complete system to hold loads mainly for Pantech truck bodies.

- Adjustable Ratchet from 2.4 metre to 2.7metre.
- Manufactured from steel with rubber padded foot pad.

CODE	ITEM	LENGTH (m)	Wt. (kg)
205602	Cargo Bar	2.26 -2.63	6.75

Shoring Bar



Loadmax Shoring Bar together with F-Track is the complete lightweight system to hold loads mainly for Pantech truck bodies.

- Spring loaded to be adjustable from 2.26 metre to 2.63 metre.
- Manufactured from lightweight steel with zinc plated finish.

CODE	ITEM	LENGTH (m)	Wt. (kg)
205603	Shoring Bar	2.4 -2.7	9.2

Jack Bar



Loadmax Jack Bar fitted with adjustable Ratchet and rubber padded feet is the complete system to hold loads mainly for Pantec truck bodies.

- Adjustable ratchet from 2.2 metre to 2.9metre.
- Manufactured from square steel with rubber padded foot pad.

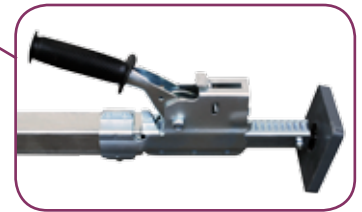

CODE	ITEM	LENGTH (m)	Wt. (kg)
205604	Jack Bar	2.1-2.9	7

Winch Track



Loadmax Winch Track together with Truck Winches are a practical solution for load restraint applications as Winches are tucked under the deck.

- Standard length of 2.4 metre with 4mm gauge thickness.
- Manufactured from steel with zinc coated finish.

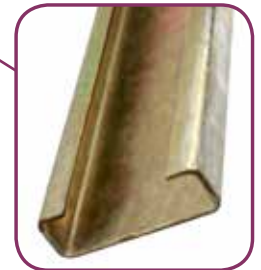

CODE	ITEM	LENGTH (m)	Wt. (kg)
205500	Winch Track	2.4	12

Winch Bars

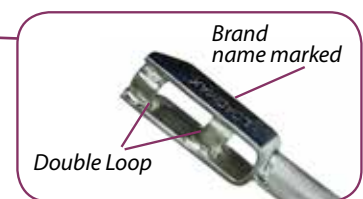
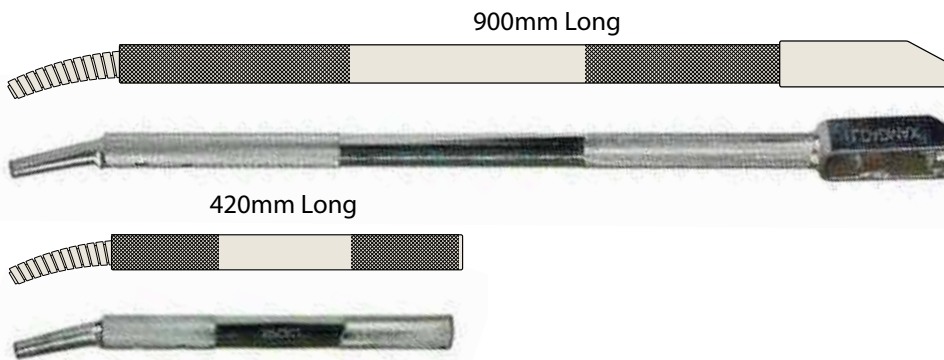

Loadmax Winch Bars are a handy tool to achieve pretension for Webbing strap and also safely release a Chain lashing system subject to statutory requirements.

- Bar length available 420mm and 900mm.
- Manufactured from steel knurled handle and double looped to keep bar inline with Load Binder handle chrome plated finish.



Note: Never use Winch Bar to tighten Load Binders.
Only used for Winch pre-tensioning & releasing load tension.
Read safety warning before use.

CODE	DESCRIPTION	Wt.(kg)
206000	Winch Bar, 900mm	2.8
206001	Winch Bar, 420mm	1.5

Motorbike Tie Downs



Loadmax Motor Cycle Cam Buckle Tie Down assemblies are the complete lashing system purposely made for Motor Cycle lashing requirements.

- Lashing capacity of 250kg per pair with 25mm Webbing.
- Manufactured from high tenacity polyester Webbing, with Cam Buckle, S-hook and Snap Hook.
- ID tagged with, lashing capacity, strap length, safety information, date of manufacture, batch numbered and branded Loadmax for traceability
- Batch Test Certificate available upon request.
- Comply with AS/NZS 4380.

CODE	DESCRIPTIONS
214015	25mmx1.7M Webbing C/W Snap Hook & S hook (2 per pack)

Ratchet Tie Downs

Loadmax Ratchet Tie Down assemblies are the complete lashing system with the benefits of high pretension therefore less damage to cargo for general transport requirements.

- Lashing capacities available from 350kg to 5,000kg with Webbing widths from 25mm to 75mm.
- Manufactured from high tenacity polyester Webbing, heavy duty Hook and Keepers stamped with lashing capacity, heavy duty powder coated Ratchet Buckle.
- ID tagged on both tail and free end of strap with, lashing capacity, strap length, safety information, date of manufacture, batch numbered and branded Loadmax for traceability.
- Batch Test Certificate available upon request.
- Comply with AS/NZS 4380.

25mm Webbing

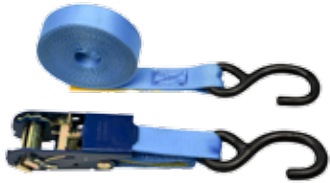

214020 C/W S Hooks



Hook/Keeper

25mm CODE	LC	END FITTING	SIZE
214020	350KG	S Hooks	25mm x 4.5M
214024	500KG	H/Keeper	25mm x 4.5M
214026	500KG	H/Keeper	25mm x 6M

35mm Webbing



214030 C/W S Hooks



214035 C/W Hook/Keeper

35mm CODE	LC	END FITTING	SIZE
214030	500KG	S Hooks	35mm x 6M
214035	1500KG	H/Keeper	35mm x 6M

50mm Webbing



214251 C/W J Hooks



Hook/Keeper

50mm CODE	LC	END FITTING	SIZE
214250	2500KG	H/Keeper	50mm x 9M
214251	2500KG	J Hook	50mm x 9M
214350	2500KG	H/Keeper	50mm x 11M
214353	2500KG	H/Keeper	50mm x 13M
214354	2500KG	H/Keeper	50mm x 16M

75mm Webbing



75mm CODE	LC	END FITTING	SIZE
214355	5000KG	H/Keeper	75mm x 9M

Loadmax Reverse action Ratchet Tie Down assemblies are the complete lashing system with the benefits of pull down action of the Ratchet Buckle also high pretension and less damage to cargo for general transport requirements.

- Lashing capacities available 2,500kg Webbing width 50mm
- Manufactured from high tenacity polyester Webbing, heavy duty Hook and Keepers stamped with lashing capacity heavy duty powder coated Ratchet Buckle.
- ID tagged on both tail and free end of strap with, lashing capacity, strap length, safety information, date of manufacture, batch numbered and branded Loadmax for traceability
- Batch Test Certificate available upon request.
- Comply with AS/NZS 4380.



CODE	LC	SIZE
214255	2500KG	50mm x 9M

Truck (Replacement) Winch Straps

Loadmax Winch Straps combined with Truck Winches are the complete lashing system with the benefits of high pretension and less damage to cargo for general transport requirements.

- Lashing capacities available from 2,500kg to 5,000kg with Webbing widths from 50mm to 75mm.
- Manufactured from high tenacity polyester Webbing with 2 x protective sleeves, heavy duty Hook and Keepers stamped with lashing capacity.
- ID tagged with, lashing capacity, strap length, safety information, date of manufacture, batch numbered and branded Loadmax for traceability
- Comply with AS/NZS 4380 with batch Test Certificate available upon request.



CODE	LC	END FITTING	SIZE
215301 Suit to Gate winch	2500KG	H/Keeper	50mm x 5M
215315	2500KG	H/Keeper	50mm x 9M
215320	2500KG	H/Keeper	50mm x 11M
215323	2500KG	H/Keeper	50mm x 13M
215325	3000KG	H/Keeper	75mm x 9M
215330	5000KG	H/Keeper	75mm x 9M



Hook/Keeper



Silver Rope

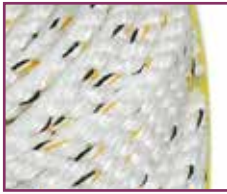

Loadmax Transport Silver Rope gives the benefits of superior strength, wear and abrasion resistant, water proof and provide excellent knotting properties generally for the transport, industrial and shipping industries however Silver Rope has many other applications.

- Rope diametres available from 6mm to 12mm in 125 metre and 250 metre coils
- Manufactured with a 3 strand Hawser Laid from polyethylene textile.
- An information card with lashing capacities and knot tie guide also provided.
- All Silver Ropes are white in colour with a strand flek to identify lashing capacity.
- Batch Test Certificate available upon request.
- Comply with AS/NZS 4345

CODE 125M	250M	SIZE	FLECK COLOR	LC
208005	208010	6mm	Blue, Black	160kg
208015	208020	8mm	Blue, Black	280kg
208025	208030	10mm	Blue, Yellow	430kg
208035	208040	12mm	Blue, Green	600kg

Silver Rope Hanks



Loadmax Transport Silver Rope come in handy hanks with the benefits of superior strength, wear and abrasion resistant, water proof and provide excellent knotting properties generally for the transport, industrial and shipping industries however Silver Rope has many other applications.

- Rope diametres available from 6mm to 12mm in 6 metre to 12 metre hanks
- Manufactured with a 3 strand Hawser Laid from polyethylene textile.
- An information card with lashing capacities and knot tie guide also provided.
- All silver ropes are white in colour with a strand flek to identify lashing capacity.
- Batch Test Certificate available upon request.
- Comply with AS/NZS 4345.

CODE	DESCRIPTION
280606	6mm x 6mtr SILVER ROPE HANKS
281008	8mm x 8mtr SILVER ROPE HANKS
281010	10mm x 10mtr SILVER ROPE HANKS
281212	12mm x 12mtr SILVER ROPE HANKS

Using Ropes and Knots

Using Ropes and Knotting

Ropes are attached to the tie rails and tensioned using knots. To be effective, the right knot must be used and correctly tied.

When tensioning a rope using a 'truckies' hitch, avoid injury by ensuring the rope does not break or cut on a sharp object or a knot does not slip and undo.

After a rope is tightened, the initial tension will usually relax after a very short time and the rope may need re-tightening

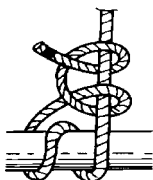

ROUND TURN & TWO HALF HITCHES

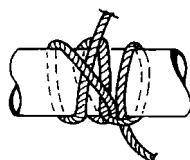

CLOVE HITCH & HALF HITCH

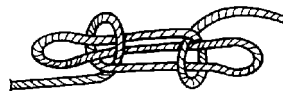

SHEEPSHANK



SINGLE SHEET BEND

Rubber Tarp Straps

Loadmax Rubber Tarp Straps generally used to tie down tarps for the transport industry. However Tarp Straps have many other applications.

- Tarp strap lengths available from 9" to 41"
- Manufactured from elasticized rubber compound with hi-tensile S-Hooks.
- All tarp straps have safety warning information impregnated into strap.



Eye protection must be used when using Rubber Tarp Straps.



CODE	LENGTH	MAX. STRETCH
207003	9"	16"
207005	15"	25"
207010	21"	36"
207015	31"	44"
207020	41"	54"

Snatch Straps

Austlift Snatch Straps are manufactured from Hi-tendency 100% Nylon Webbing to ensure a minimum stretch of 20% suitable for 4WD recovery and towing applications.

- 10,000kg minimum break strength with a minimum stretch of 20%.
- 100% Nylon Webbing in 9 metre strap length as standard.
- Reinforced eyes for added protection from abrasion.
- Straps come with safety information tag.

CODE	LENGTH	MBS
204390	75mmx9m	10,000kg
204391	125mmx9m	15,000kg
204392	200mmx9m	30,000kg



Vehicle Ratchet Tie Down

CODE	LC	END FITTING	SIZE
204555	2500KG	J hook	50mm x 3M



Do Not Overtake Sign

CODE	SIZE	DESCRIPTION
209101	400x400mm	Right side, Sticker / Class 2 Refl
209102	400x400mm	Left side, Sticker / Class 2 Refl
209103	400x400mm	Right side, Metal / Class 2 Refl
209104	400x400mm	Left side, Metal / Class 2 Refl



Left side



Right side

Truck Winches

21 Teeth & Double Pawl



205000

Loadmax Clip-On Standard Truck Winches are primarily fitted to truck tie rails with the benefit of a high pretension with less effort for easy operation making them an effective way to restraint heavy loads for transport applications.

- Lashing capacity of 3,000kg for Webbing or G70 Chain.
- Manufactured from medium grade hi-tensile steel gold passivated for corrosion protection.
- Marked with lashing capacity, batch numbered and branded Loadmax for traceability
- All Truck Winches come with our 21 teeth double pawl patent design as standard.
- Batch Test Certificate available upon request.
- Comply with AS/NZS 4380.



205200

Loadmax Slide-On Standard Truck Winches are primarily fitted to a Winch Track with the benefit of a high pretension with less effort for easy operation making them an effective way to restraint heavy loads for transport applications.

- Lashing capacity of 3,000kg for Webbing or G70 Chain.
- Manufactured from medium grade hi-tensile steel gold passivated for corrosion protection.
- Marked with lashing capacity, batch numbered and branded Loadmax for traceability
- All Truck Winches come with our 21 teeth double pawl patent design as standard.
- Batch Test Certificate available upon request.
- Comply with AS/NZS 4380.



205207

Loadmax Gate Truck Winches are primarily fitted to the under body of the trailer for lashing truck gates with the benefit of a high pretension with less effort for easy operation.

- Lashing capacity of 3,000kg for 5 metres of Webbing
- Manufactured from medium grade hi-tensile steel gold passivated for corrosion protection.
- Marked with lashing capacity, batch numbered and branded Loadmax for traceability
- All Truck Winches come with our 21 teeth double pawl patent design as standard.
- Batch Test Certificate available upon request.
- Comply with AS/NZS 4380.



205215

Loadmax Heavy Duty Truck Winches are primarily fitted to the under body of the trailer for lashing truck gates with the benefit of a high pretension with less effort for easy operation.

- Lashing capacity of 5,000kg for 9 metres of Webbing
- Manufactured from medium grade hi-tensile steel gold passivated for corrosion protection.
- Marked with lashing capacity, batch numbered and branded Loadmax for traceability
- All Truck Winches come with our 21 teeth double pawl patent design as standard.
- Batch Test Certificate available upon request.
- Comply with AS/NZS 4380.



AUSWINCH

International Patent No.: PCT/AU2009/001455

Australian Patent No.: 2009317858

Design No.: 305232

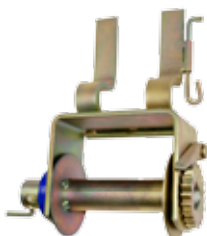

CODE	204990	205090	204995	205095
Products	Clip on, LC3000KG AusWinch (Bare Winch)	Slide on, LC3000KG AusWinch (Bare Winch)	Clip on, LC3000KG Ratchet Winch 50mmx9M	Slide on, LC3000KG Ratchet Winch 50mmx9M

Standard Truck Winch



Slide-on Winch



Clip on Winch



Gate Winch



Heavy duty Winch

CODE	205200	205000	205207	205215
Products (Bare Winch)	Slide-on, LC3000KG Std. Winch (Bare Winch)	Clip on, LC3000KG Std. Winch (Bare Winch)	Gate Winch, LC3000KG (Bare Winch)	H/Duty Winch, LC5000KG (Bare Winch)



Slide-on Winch



Clip on Winch



Gate Winch



Heavy duty Winch

CODE	205203	205003	205208	205210
Products (With Strap)	Slid on, LC3000KG Std. Winch 50mmx9M	Clip on, LC3000KG Std. Winch 50mmx9M	Gate Winch, LC3000KG 50mmx5M	H/Duty Winch, LC5000KG 50mmx9M

Ratchet Buckles

Loadmax Ratchet Buckles and Cam Buckles are used for a tie down accessory combined with Webbing generally for the transport industry also has many other applications .

- Lashing capacities from 200kg to 5,000kg available.
- Suits Webbing sizes from 25mm to 75mm.
- Manufactured from hi-tensile steel.
- Marked with lashing capacity.



38mm Ratchet
LC 1250kg
Blue or Black
Powder Coated
Code: 204035



50mm Ratchet
LC 2500kg
Blue or Black
Powder Coated
Code: 204350



50mm Ratchet
LC 1000kg
Blue or Black
Powder Coated
Code: 204150



75mm Ratchet
LC 5000kg
Blue or Black
Powder Coated
Code: 205325



50mm Ratchet
LC 2500KG
Gold Zinc
Code: 204360



25mm Ratchet
LC 400kg
Powder Coated
Code: 204020
(Gold Zinc)204020G



Cam Buckles
25mm(150kg) 206124
25mm(225 kg)206125
25mm(350kg)206126
51mm(550kg)206128



Curturn Buckle
LC 1250kg
Blue or Black
Powder Coated
Code: 206302



Keeper
Gold plated
38mm: 206157
50mm: 206350
75mm: 206159



Hooker & Keeper
Gold plated
38mm(1500Kg): 206151
50mm(2500Kg): 206152
75mm(5000Kg): 206153



Round Rings
50mm x Ø10mm
Code: 206117
76mmxØ10mm
Code: 206118



J Latch Hook Compact c/- Ratchet Buckle
38mm
LC 1500Kg
Code: 206141



Single J Hook
50mm HD LC 2500KG
Code: 206168



Double J Hook
LC 750kg 25mm: 206160
LC 1500kg 38mm: 206107

Loadmax Lashing hardware are used for a tie down accessory combined with Webbing generally for the transport industry also has many other applications .

- Lashing capacities from 200kg to 5,000kg available.
- Suits Webbing sizes from 25mm to 75mm.
- Manufactured from hi-tensile steel.
- Marked with lashing capacity.
- Conforms to AS/NZS 4380.

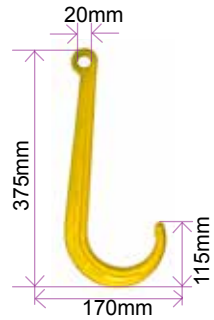

**Butterfly Hook
Truck Fitting**

LC 1000Kg

Code: 206114



S Hooks

Plastic dipped

LC (600Kg): 206102



Anchor Point

LC1250kg

Code: 206133

Eye Tow hook

LC 2455KG

Code: 201508



Delta Ring

Gold Plated

75mm, LC 5000Kg

HD Code:206306*

*Non-stocked item.



D Ring

52mm, LC2500KG

Zinc finish

Code: 206111



E Hook

52mm

Zinc finish, LC1000KG

Code: 206115



Wooden Beam Socket

Zinc finish

43mm(w) 70mm(h)

Code: 206113



Corner Protector

1000mm

Plastic

Code: 206009



Anchor Point

114x124mm

LC 1125kg

Code: 206131



Round Anchor Point

120mm

LC 275kg

Code: 206130



Eye Ring

Eye Ring 50mm

LC 4250Kg

Code:206119



Corner Protection

Webbing Type (L/D)

Plastic

100mm

Code:206007

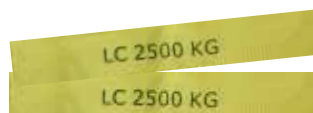

**Protection Sleeves
/Pair (Mark LC 2.5T)**

Webbing
(300mm x 50mm)

Code:204400



Flat Hook

Black finish, 51mm

LC 2200kg

Code: 206105



**Vehicle Flat
Double Hook**

50mm

LC 2500kg

Code:206103

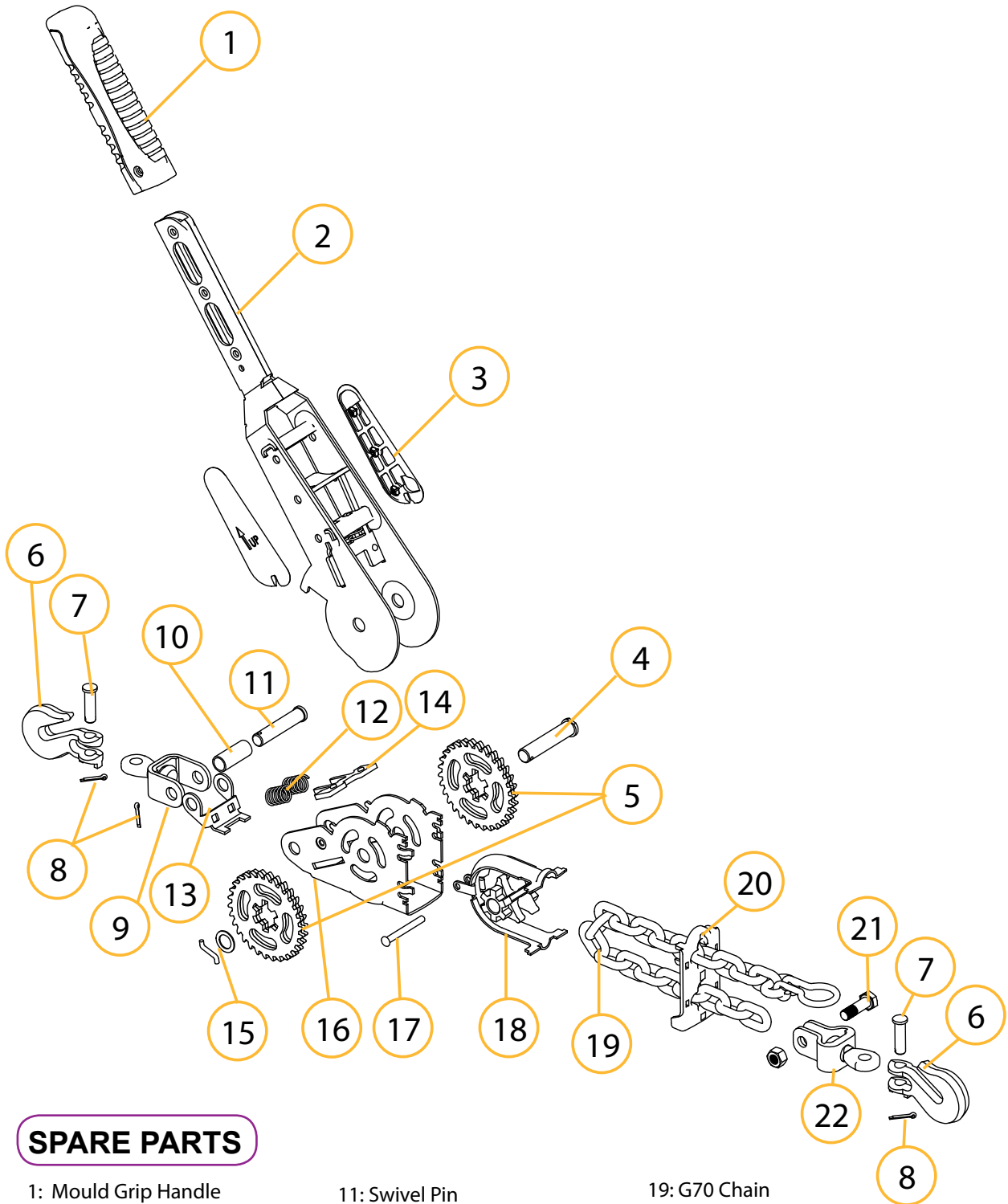

SPARE PARTS

- 1: Mould Grip Handle
- 2: Handle Assembly
- 3: Handle Cover
- 4: Gear Pin
- 5: Ratchet Gear x2
- 6: Grab Hook x2
- 7: Load Pin x2
- 8: Split Pin x3
- 9: Hook Swivel
- 10: Bush

- 11: Swivel Pin
- 12: Paw Spring
- 13: Spring Bracket
- 14: Paw
- 15: Gear Washer & Pin
- 16: Main Body
- 17: Body Pin
- 18: Chain Guard & Wheel

- 19: G70 Chain
- 20: Chain Guide
- 21: Swivel Bolt
- 22: Chain Swivel

CAUTION

Under Duty of Care laws, Load Restraint products shall comply with AS/NZS4344-2001.
Transport Chain and components AS/NZS4380-2001 Transport Webbing.

Accountability

The legal responsibility of Packing, Loading, Driving, Receiving and Operation liability stops with the driver.

New regulation

Traffic Inspectors and Police have the legal right to search and inspect your vehicle at any time and fine you on the spot.

Employees

The operator, driver and anyone else is responsible while any vehicle is used on public roads.

TRANSPORT CHAIN AND FITTINGS

- Do not use transport G70 Chain for any lifting purposes.
- The Australian Standard states that G70 Chain shall be marked with 4344 together with lashing capacity. If marking is not on Chain do not use it.
- Loadmax ensures G70 Chain is rigorously tested compliant to AS4344 and of the highest quality.
- Loadmax G70 Chain and fittings are clearly marked Grade 70 with lashing capacity "LC", size of Chain and branded Loadmax for traceability.

TRANSPORT LOAD BINDERS

- Avoid injury – operate by hand only from a standing position on firm ground.
- Load binding systems store force which can release suddenly, Stay clear of handle, as it could suddenly release with force causing personal injury.
- Regularly inspect Load Binders before using, for wear, bending, cracks and gouges. Do not use the Load Binder if any of the above are present and replace any damaged or faulty Load Binders.
- Ensure the appropriate size and grade of Chain and fittings are used with the Load Binder.
- It is not recommended to use the handle extensions (pipes or cheater bars) as they can overload and weaken the entire system.
- Ensure Load Binders are tight before moving, As loads settle in transportation you should stop and recheck tension frequently.
- Never discard warning instructions and read them for safety sake.

RATCHET ASSEMBLIES

- Loadmax Ratchet Tie Down assemblies have the lashing capacity on Safety Tags, Ratchet Buckle also Hook and Keepers to aid the operator to select the correct lashing system for the load to be transported.
- Loadmax Ratchet Buckles are powder coated together with safety lock to prevent the assembly to accidentally loosen or slipping of the load.
- The Webbing used for Loadmax Tie Down assemblies are manufactured from high tendency polyester yarn for superior strength and pretension.
- All Heavy Duty Tie Down assemblies come with reinforced eyes for the Hook and Keepers and 2 x wear protective sleeves to add life to the assembly.
- Sewn into both ends of the assembly are ID tags with safety information, lashing capacity, date of manufacture and branded Loadmax for traceability.

TRUCK WINCHES

- Ensure the strap used on the Winch is tensioned during transporting
- as loose straps will wear prematurely over tight straps.
- Regularly inspect the Pawls and Cog Teeth for any damage, and check they are in good working order.
- Ensure the correct Winch is selected for the appropriate transport application.
- For Clip-on type Winches, make sure the bar arms are straight and show no signs of distortion.
- It is recommended that at least three turns of Webbing remains on the Winch Drum to provided enough friction hold to the Winch.

UNDERSTANDING G FORCES

When cornering, stopping, accelerating, and in emergencies loads are subjected to G forces. During transport operation this can lead to a variety of movements of the load which may create serious hazards to both the driver and other road users, Shifting loads can cause serious destabilization of the vehicle, or penetration of loads through the cabin, particularly in emergency braking situations. Therefore G forces must be taken into consideration when specifying Load Restraint equipment.

DIFFERENT METHODS FOR RESTRAINT APPLICATIONS.

Tiedown-This is used to maximize the friction between the load and the deck friction co-efficient. Tiedown lashings rely on the pretension capability of the assembly and not on the overall strength of the system. Eg; if the system is capable of exerting sufficient pre-tension it is strong enough for the application.

Direct- With direct lashings the assembly strength is used to restrain the load, sometimes in several directions, with less emphasis placed on friction values. The angles of the straps can lead to a reduction in overall assembly strength. Note the use of round slings around the awkward load.

Combination- It is sometimes necessary to combine both direct and tiedown methods to particular loads. This utilizes both the strength of the direct lashing and the clamping force of the tiedown.

SAFETY LASHING TIPS:

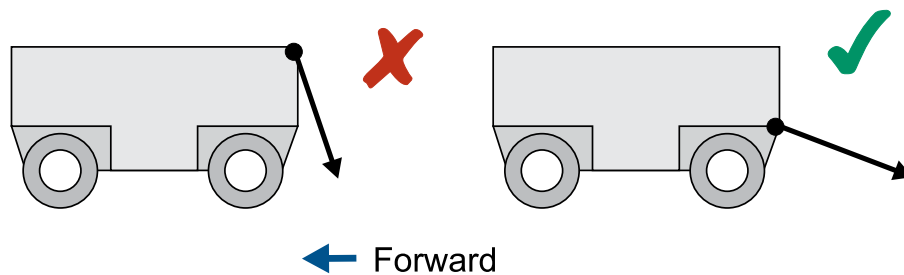

DIRECT LASHING ANGLES (front lashings not shown)

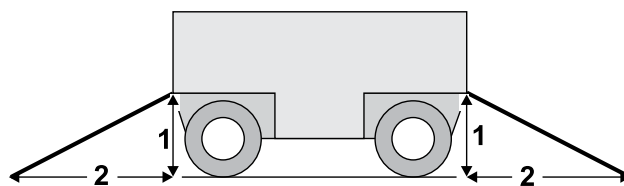

RECOMMENDED DIRECT LASHING ANGLE

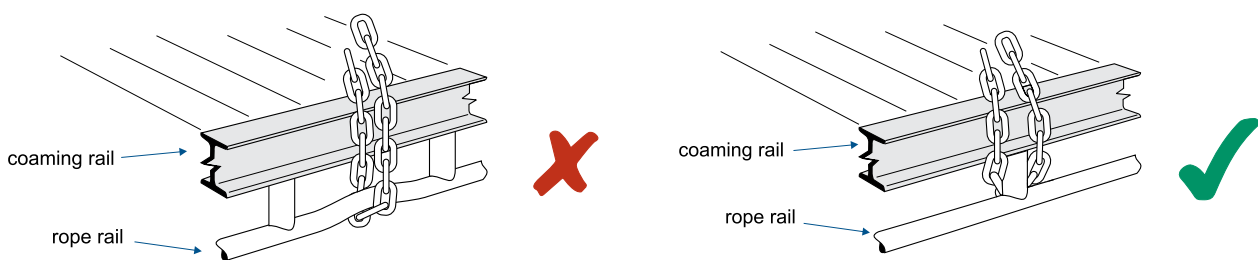

CORRECT (at support point)

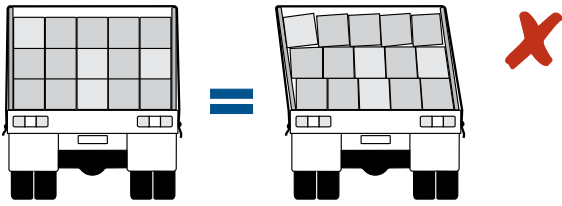

STACKED PACKS

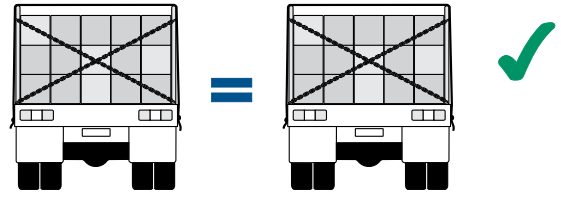

GATES CROSS TIED

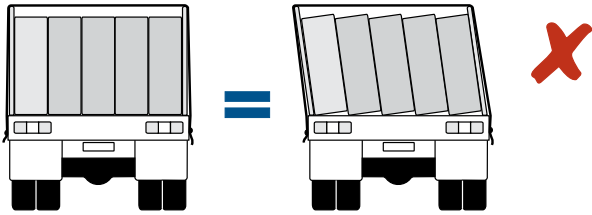

TALL UNSTABLE PACKS

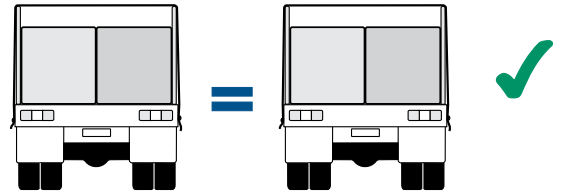

STABLE RIGID PACKS

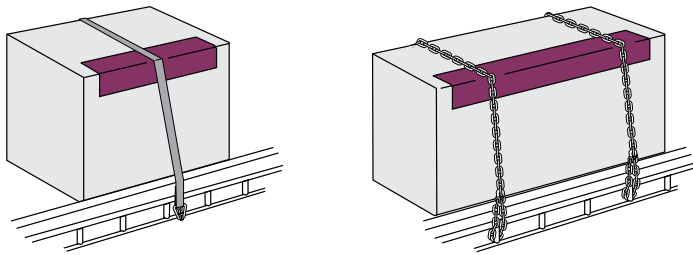

LASHING AND LOAD PROTECTION

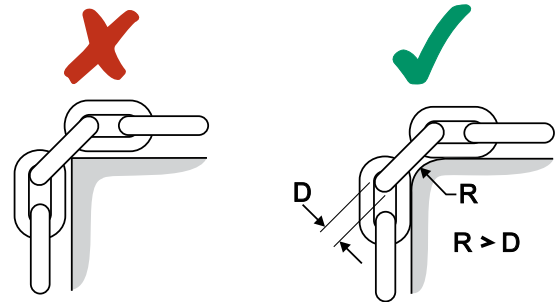

CHAIN OVER SHARP CORNER





4WD RECOVERY

Wire Rope Hoist



Complete with 20m wire rope assembly & reeler

As well as lifting and hauling loads Austlift Wire Rope Hoist are also ideally used for 4WD off road recovery.

- Compact lightweight and robust in construction.
- Recommended for portable applications.
- Able to be operated at any angle easy to handle.
- Hoists come with Wire Rope. Longer lengths available.
- Hoists are individually proof tested and serial numbered.
- All hoists have spare shear pins in handle.
- Conforms to AS1418.2 with instruction manual.

CODE	135008A	135016
WLL	800kg	1600kg
Pulling Capacity	1250kg	2500kg
Wire rope	8.3mm	11.4mm
Construction	6x19S+IWRC	6x25Fi+IWRC
Advance/pull	52mm	55mm
Handle force	343N	438N

Grab Hook

with supporting lugs



Loadmax Clevis Winged Grab Hooks combined with Grade 70 Chain are an effective way to restraint heavy loads for transport operations with the benefit of a cradle built into the hook to achieve full lashing capacity.

- Manufactured from dropped forged steel quenched and tempered and gold zinc plated.
- Marked with Chain size, lashing capacity, grade, batch numbered and branded Loadmax for traceability.
- Batch Test Certificate available upon request.
- Comply with AS 4344.

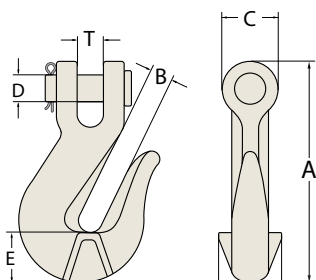

CODE	SIZE	L.C	Wt.	DIMENSIONS						
				A	B	C	D	E	F	T
	mm	kg	kg	mm	mm	mm	mm	mm	mm	mm
201008	8	3800	0.35	95	12	23	11.5	24.5	31.5	11.5

Clevis Slip Hook

Loadmax Clevis Slip Hooks combined with Grade 70 Chain are an effective way to restraint heavy loads for transport operations with the benefit of a hook style fitting for all sorts of lashing applications.

- Manufactured from dropped forged steel quenched and tempered and gold zinc plated.
- Marked with Chain size, lashing capacity, grade, batch numbered and branded Loadmax for traceability.
- Batch Test Certificate available upon request.
- Comply with AS 4344.

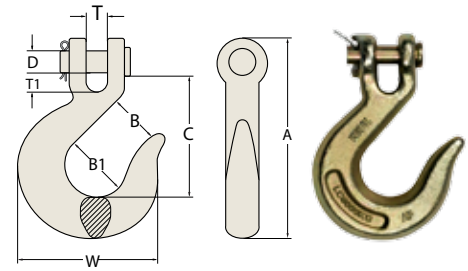

CODE	SIZE	LC	Wt.	DIMENSIONS								
				A	B	B1	C	D	T	T1	W	
	mm	t	kg	mm	mm	mm	mm	mm	mm	mm	mm	mm
201308	8	3.8	0.33	114	27	32	74	9.9	13	13.4	75	

Recovery Drag Chain Kit

Loadmax G70 Drag Chain Kits gives considerably higher load bearing capacity when required for 4WD recovery, towing, logging and other agricultural applications .

- Chain Kits available from 8 to 13mm and supplied with Lug link, Grab Hook or Slip Hook.
- Supplied at 5 metre length as standard however longer lengths can be supplied upon request.
- All Grade 70 Drag Chain Kits come with re-usable plastic containers.
- Batch Test Certificate available upon request.
- Comply with AS 4344.

CODE	SIZE
Lug Link Grab Hook	Chain size x L
203408	8mm X 5M
203410	10mm X 5M
203413	13mm X 5M



Ratchet Tie Downs

CODE	LC	END FITTING	SIZE
204020	250KG	S Hooks	25mm x 4.5M
204030	500KG	S Hooks	35mm x 6M
204035	1500KG	H/Keeper	35mm x 6M



Snatch Straps
 MBS 10,000 kg
 75mm x 9metre
 Code: 204390



Off Road Block c/w Vinyl Bag
 MBS 8,000 kg, Sheave 125mm
 For 11mm Wire Rope Only
 Code: 204395

Gold Screw Pin , Bow Type Grade 'S' Shackle

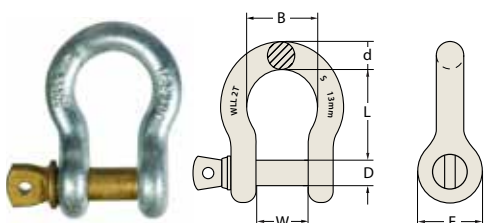

CODE	SIZE	WLL	Wt.	DIMENSIONS						
				B	D	d	E	L	W	
	mm	T	kg	mm	mm	mm	mm	mm	mm	
503016	16	3.2	0.63	43	19	16	40	61	27	
503019	19	4.7	1.02	51	22	19	48	72	32	

SYDNEY

43 Frank Street Wetherill Park, NSW 2164
T. 02 9757 2277 F. 02 9757 2922

MELBOURNE

47 Technology Drive, Sunshine West VIC 3020
T. 03 9314 5525 F. 03 9314 5526

PERTH

Unit 5, 2-4 Mallaig Way Canning Vale WA 6155
T. 08 9256 3440 F. 08 9256 4408

BRISBANE

7 Durbell St Acacia Ridge, QLD 4110
T. 07 3272 0777 F. 07 3272 0788

www.austlift.com.au